

E420



MANUAL
English



CONTENT

INTRODUCTION	1	CHOOSE PROGRAM	23
Service and calibration	3	Preparations	23
Travelling with your measurement system	4	PROGRAM VALUES	25
DISPLAY UNIT	5	Tolerance	26
Reset the Display unit	5	Zoom	26
Navigation buttons	6	Halve or Zero set value	27
Function buttons	6	Live values – colours	27
Status bar	7	Automatic recording	28
Screen dump	8	Precision level E290	28
LED lights	8	Calibration check	29
Battery	9	HORIZONTAL	31
Power adaptor	9	Mount the units	32
Charge measuring units	9	Bluetooth®	32
Calculator	10	Enter distances	34
Measurement file handling	11	Measure using Easy Turn™	35
Save file	11	Measure using 9-12-3	36
File manager	11	Result and adjust	37
Favourites	12	Live values	38
Open file as template	13	Thermal compensation	40
Copy file to USB memory	13	Tolerance	41
Barcode	13	SOFTFOOT	43
Print file (Optional)	14	VERTICAL	45
Control panel	15	Preparations	45
Filter	15	Measure	46
Unit and resolution	16	Result	47
Language	16	Adjust machine	48
User	16	TECHNICAL DATA	49
Backlight	17	Display unit E53	50
Automatic power off	17	Measuring units	51
VGA	18	INDEX	53
System update	19		
License	20		

INTRODUCTION

Damalini AB

Damalini AB develops, manufactures and markets Easy-Laser® measurement and alignment equipment based on laser technology.

We have more than 25 years of experience from measurement tasks in the field and product development. We also provide measurement service, which means that we ourselves use the equipment we develop, and continuously improve it. Because of this we dare to call ourselves measurement specialists.

Do not hesitate to contact us about your measurement problems. Our expertise will help you solve it in an easy way.

Declaration of conformity

Equipment: Easy-Laser® product range

Damalini AB declares that the Easy-Laser® product range is manufactured in conformity with national and international regulations.

The system complies with, and has been tested according to the following requirements:



EMC Directive	2004/108/EG
Low Voltage Directive	2006/95/EC
Laser Classification	Europe: SS_EN 60825-1 USA: CFR 1040.10/11
RoHs Directive	2011/65/EU
WEEE Directive	2012/19/EU

The calibration of the equipment fully complies with ISO9001:2008 #7.6

For Bluetooth® devices: This device complies with Part 15 of the FCC Rules.

Operation is subject to the following two conditions:

- (1) this device may not cause harmful interference
- (2) this device must accept any interference received, including interference that may cause undesired operation.



Disposal of old electrical and electronic equipment (Applicable throughout the European Union and other European countries with separate collection programs)



This symbol, found on product or on its packing, indicates that this product should not be treated as household waste when disposed of.

It should be handed over to an applicable collection point for the recycling of electrical and electronic equipment. By ensuring this product is disposed correctly, you will help to prevent potential negative consequences to the environment and human health. For more detailed information about the recycling of this product, please contact your local city office, household waste disposal service or the retail store where you purchased this product.

Quality certificate

Damalini AB is ISO 9001:2008 certified. Certificate number 900958.

Damalini AB confirm, that our products are produced according to applicable national and international regulations and standards. All components are checked before assembly and final products are tested in functionality and visually checked before delivery

The calibration of the equipment fully complies with ISO9001: 2008 #7.6

Limited warranty

This product is manufactured under Damalini's strict quality control system. Should the product fail within two (2) years from the date of purchase under normal usage conditions, Damalini will repair or replace the product free of charge.

1. Using new or refurbished replacement parts.
2. Exchange the product with a product that is new or which has been manufactured from new or serviceable used parts and is at least functionally equivalent to the original product.

Proof of purchase date should be confirmed, and sent together with a copy of the original purchase document.

Warranty is valid under normal usage described in the user's manual appended with the product. The warranty comprises failure on Easy-Laser® product that could be related to material and/or fabrication errors. The warranty is valid only in the country of purchase.

The warranty is not valid in the following cases:

- If the product is broken due to mishandling or incorrect operation
- If the product has been exposed to extreme temperature, calamity, chock or high voltage.
- If the product has been modified, repaired or disassembled by unauthorized personnel.

Compensation for possible damage due to failure on Easy-Laser® product is not included in the warranty. Freight cost to Damalini is not included in the warranty.

Note!

Before delivery of the product for warranty repair, it is the responsibility of the buyer to backup all data. Data recovery is not included in the warranty service and Damalini is not responsible for data that may be lost or damaged during transit or repair.

Lithium Ion battery limited warranty

Lithium ion batteries inevitably lose power during their lifetimes, depending on usage temperatures and the number of charging cycles. Therefore, the internal rechargeable batteries used in the E-series are not included in our general 2-year warranty. There is a 1 year warranty for the battery capacity not to fall below 70 % (a normal change means that the battery must have more than 70 % capacity after more than 300 charging cycles). A 2 year warranty applies if the battery becomes unusable because of a manufacturing fault or factors that Damalini AB could be expected to have control of, or if the battery displays abnormal loss of capacity in relation to use.

Extended warranty

Easy-Laser® Measurement and Alignment Systems meet the highest quality standards! For this reason, we have extended the warranty to you to a total of 3 years — free of charge!

The prerequisite for a warranty extension is that you register your system parts on the Internet within 6 months of purchase. The warranty period begins on the date of purchase. The warranty extension applies to all products in accordance with the Easy-Laser® Warranty requirements.

Safety precautions

Easy-Laser® is a laser instrument in laser class II with an output power less than 1 mW, which requires the following safety precautions:

- Never stare directly into the laser beam
- Never aim the laser beam at anyone else's eyes.



Note!

Opening the laser units can result in hazardous radiation, and will invalidate the manufacturer warranty.

If starting the machine to be measured would result in injuries, the possibility to unintentionally start it must be disabled before mounting the equipment, for example by locking the switch in the off position or removing the fuses. These safety precautions should remain in place until the measurement equipment has been removed from the machine.

Note!

The system should not be used in explosive risk areas.

Service and calibration

Our Service centres will quickly assist you if your measurement system need to be repaired or when it is time for calibration.

Our main Service centre is located in Sweden. There are several local Service centres that are certified to carry out limited service and repair. Contact your local Service centre first before sending your equipment for service or repair. All Service centres are listed on our web site under Service and Calibration.

Before sending your measuring system to our main Service centre, please fill in the online Service and Repair report. www.easy-laser-service.com



Manuals as PDF

You can download our manuals in pdf format from our website. The pdf's are also available on the USB memory stick that is delivered with most systems.

EasyLink

The new version of our database program EasyLink is available on the USB memory stick that is delivered with most systems. You can always download the latest version from damalini.com>download>software.

Travelling with your measurement system

When travelling by airplane with your measurement system we strongly recommend that you check which rules apply for each airline company. Some companies/countries have limitations for checked baggage when it comes to items including batteries. For information about Easy-Laser® batteries, please see system unit details in the end of this manual. It is also good practice to remove the batteries from the equipment, when possible, e.g. D22, D23 and D75.

Compatibility

The E-series is not compatible with previous analogue units from the D-series. You can however continue to use previous brackets.

Disclaimer

Damalini AB and our authorized dealers will take no responsibility for damage to machines and plant as a result of the use of Easy-Laser® measurement and alignment systems.

Copyright

© Damalini 2015

We might change and correct the manual in later issues without further information. Changes to the Easy-Laser® equipment may also affect the accuracy of the information.

May 2015



Fredrik Eriksson
Quality Manager, Damalini AB

Damalini AB, PO Box 149, SE-431 22 Mölndal, Sweden
Phone: +46 31 708 63 00, E-mail: info@damalini.com
Web: www.damalini.com

DISPLAY UNIT

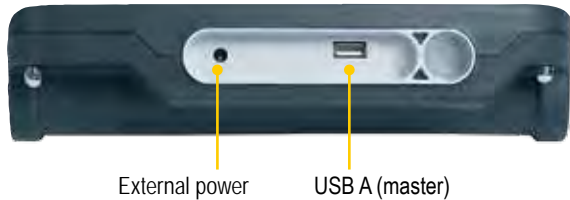

Escape

Escape will either return to start view, or close active window (for example file manager) and return to previous view.

On/Off

When you select sleep mode, the Display unit goes into a low-power mode. When in sleep mode, the Display unit restores itself quickly. In sleep mode, the yellow LED light is flashing.



Sleep mode



Shut down



Cancel

Note!

Shut down the system completely when not using it for a long time. The system consumes power also in sleep mode.

Reset the Display unit

Press and hold the On/Off button to reset the Display unit.

Navigation buttons





To navigate on the screen, use the navigation buttons. The selected icon is marked with a yellow frame. The navigation buttons are also used to move between the icons in a submenu and to change the values in the fields.



Function buttons

The icons above the function buttons change depending on which view is currently displayed on screen.

Below is a list of the most common icons.

	Back to previous view. Press and hold to leave current program.
	Back. There is no “previous view”. Leave the current program.
	More. Contains a submenu with general functions, such as  (Control panel) and  (Save file).

Submenus

The icons formed as an arrow contain a submenu. Use the navigation buttons to navigate in a submenu. Press  to select.

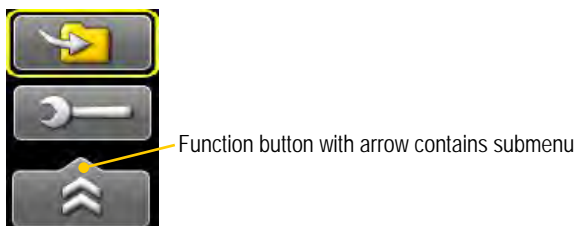

Status bar

The Status bar contains additional information such as warning icon, current time and Bluetooth® connection.



There are also text messages regarding:

- The selected icon.
- Hints on what information you are expected to fill in.

Status bar icons

	Warning. Select the function button to get additional information regarding the warning.
	Warning. Displayed when the coordinates has been rotated in the detector. Go to Control panel to rotate coordinates.
	Hourglass. The Display unit is in the middle of a task.
	Display unit charging. Indicating that a power adaptor is plugged in.
	Display unit is low in battery.
	Measurement progress. Time depending on which filter you have selected.
	Selected filter.
	Peripheral. Indicates that a peripheral device is plugged in, such as a projector. <i>Not available for E420.</i>
	Bluetooth®. Indicates that the Bluetooth® functionality is activated. The number beside indicates the number of Bluetooth® units connected.
	Printing report on thermal printer. The thermal printer is optional equipment.
	Printing performed OK.
	Printing problem.

Screen dump

It is possible to take screen dumps of what is currently displayed on screen. You can e-mail the screen dump or use it for reports.

Take a screen dump

1. Press and hold the numeric button period (.) for 5 seconds.
2. An hour glass is displayed on the status bar.
3. The screen dump is saved in the file system as a .jpg file. It is named with current date and time. Select  to open saved files. See “Measurement file handling” on page 11.

LED lights

Battery

While the battery is charging, the LED light will be flashing green.

 Red, flashing once: Battery empty.

 Red, flashing twice: Battery needs charging.

 Green, flashing three times: Good.

 Green, fixed light: Battery full.

Information light

 Blue flashing light: Searching for Bluetooth® connection.
Blue fixed light: Bluetooth® connection is established.

 Green flashing light: The Display unit is starting.

 Yellow flashing light: The Display unit is in sleep mode.

 Red flashing light: Warning. Select  and  for information.

Battery

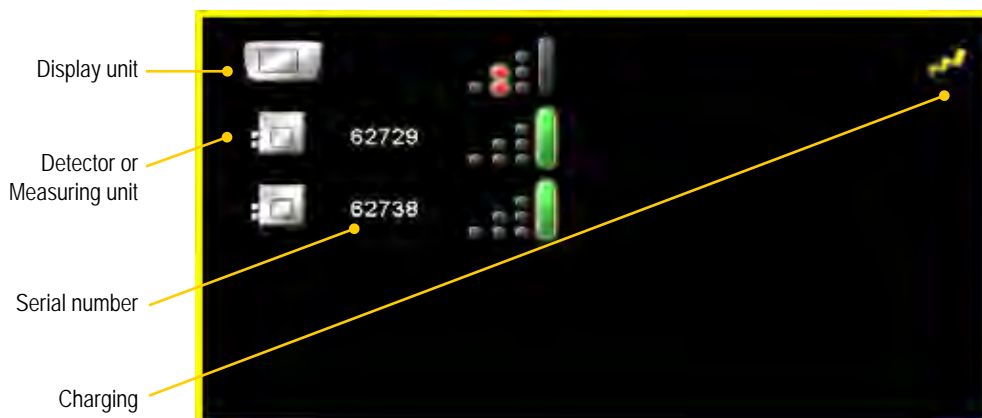

Battery symbols correspond to the LED signals on the Display unit.

The E-series is **not** compatible with units from the D-series.

Power adaptor

With the power adaptor plugged in, you can keep on working.

Charge measuring units

Use the splitter charge cable to charge the units. You can plug in the detectors via the splitter cable to the Display unit, or to the standard power adaptor.

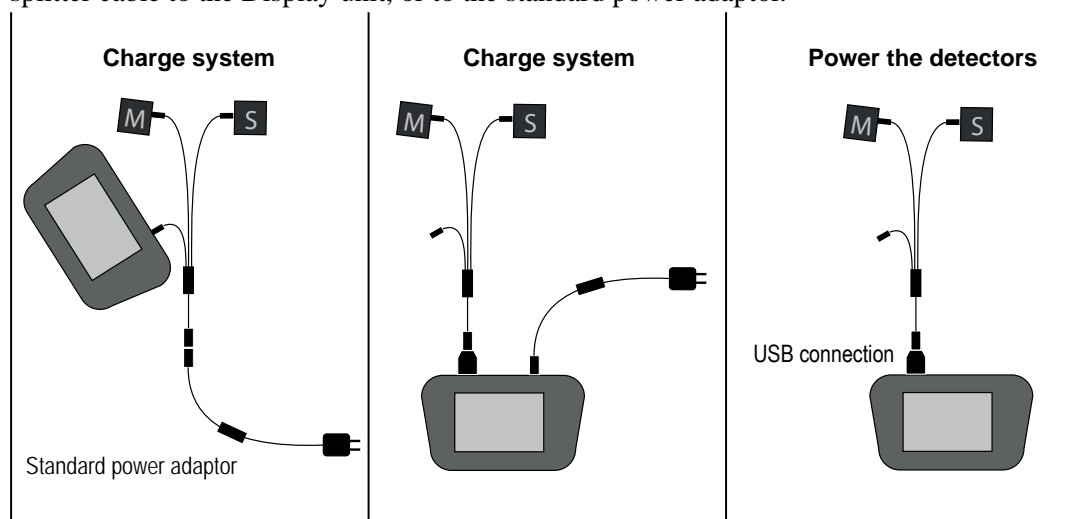





12-0750



12-0751

Calculator



The calculator is found on the Start view and Control panel ().

1. Select  and  to open the calculator.
2. Use the numerical buttons and function buttons to enter values.
3. Use the  button to compute.



Unit converter

The unit converter is found on the Start view and Control panel ().

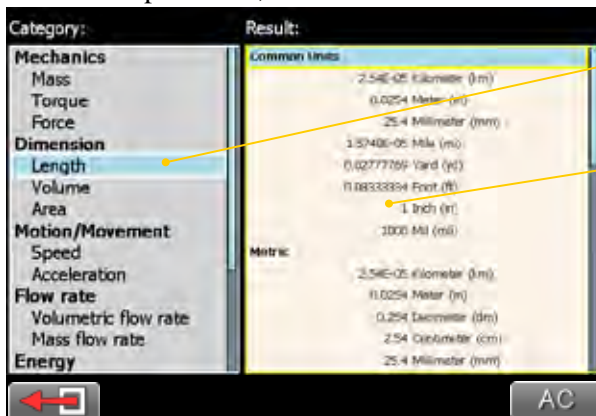

1. Select  and  to open Unit converter.
2. Select a category. Move using the navigation buttons up and down.
3. Press navigation button right. The result column is activated.
4. Select a unit to convert from.
5. Enter an amount. The other units are recalculated.

In the example below, one inch is selected.





Measurement **file handling**

Save file

1. Select  and  to save your measurement.
2. Enter a file name. The date and time will automatically be added to the file name.
The measurements that you save will be available to other users as well.
3. Press  to save the file.

File manager

Select  (found on the start view and Control panel) to open saved measurements. The File manager is displayed. Here you can easily when and from which program the file was saved.

Press  to open a measurement file.

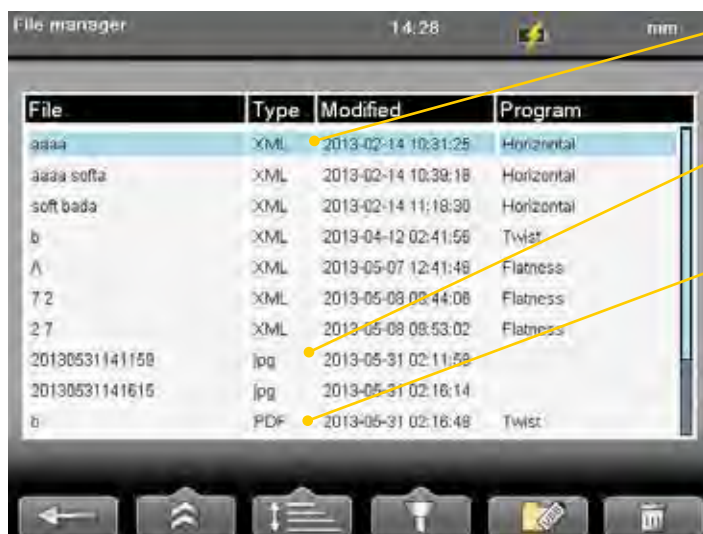

















xml
A measurement file.

jpg
"Screen dump" on page 8

PDF
A report. The PDF report can not be opened in the Display unit.
PDF is not available for E420.





Function buttons

	Back to previous view.
	 "Open file as template" on page 13.  "Print file (Optional)" on page 14.
	 Sort files alphabetically.  Sort files by measurement program.  Sort by time.
	 Show all files.  Show only xml files.  Show only pdf files.  Show only jpg files.  Show only Favourites. See "Favourites" on page 12.
	"Copy file to USB memory" on page 13.
	Delete files. Delete all displayed files or only selected file.

Favourites

It is possible to save a measurement as a Favourite. A Favourite can be used for example when you have many flanges or machines with the same dimensions. This way you do not have to enter the same distances or tolerances every time. When you have saved as Favourite, a new icon is displayed on the start screen.



Create a favourite

1. Select  to open the File manager and select a file.
2. Select  and  to save the selected file as a Favourite.
3. Go to the start screen and select  to see all favourites.
4. Press  to open a Favourite. All distances are filled in.







Import favourites

The favourite files are saved in the folder Favourites in the Display unit.

1. Plug in the Display unit to a PC and open the Favourites folder.
2. Copy the .FAV (favourite) file to the root of an USB memory stick.
3. Connect the USB stick to a Display unit and select  and  to import.

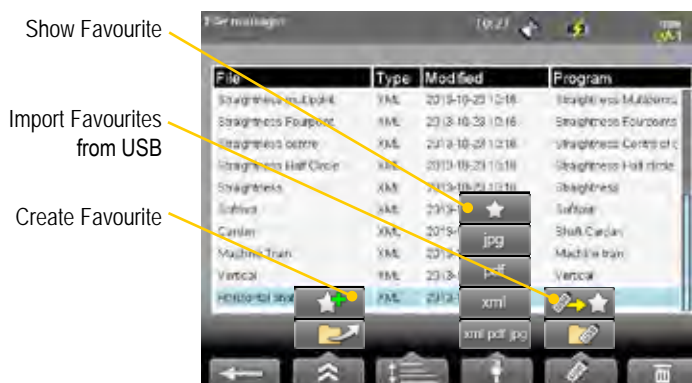

Delete favourite

1. Select  to open the File manager and select a file.
2. Select  and  to show all Favourite files.
3. Select a file and .



Open file as template

You can open a saved measurement and use it to make a new measurement. This is very useful when you have many flanges or machines with the same dimensions for example. This way you do not have to enter the same distances every time.

1. Select  (found on the Start view and Control panel). The File manager is displayed.
2. Select a file in the list and select . The Edit distance view is displayed.
3. Change distances if needed and proceed to measuring view.

Copy file to USB memory

You can easily copy a saved measurement or other files to a USB memory.

1. Insert a USB memory.
2. Select the file you want and select .
3. A folder is automatically created on the USB memory. The file is saved in the folder \Damalini\archive\.

Barcode

Save file with barcode

The barcode scanner is not included in all systems. The first time you measure a machine, you stick a barcode on the machine and save the measurement together with the scanned barcode. Next time you align the same machine, all you need to do is scan the barcode and all machine data is read.

1. Scan the barcode on the machine.
2. Enter a file name.
3. Press  to save the file. All measurement data is saved together with the barcode.

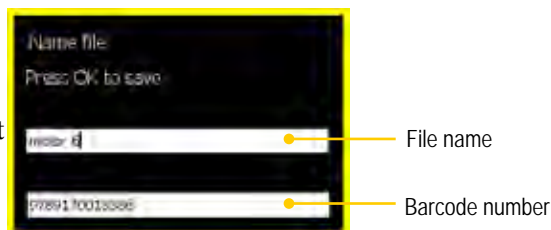

The barcode number is added to the file name.



Open file with barcode

- Start the Display unit and scan the barcode. The **latest** measurement that was made and saved with this barcode is automatically opened.
- OR**
- Select  to open File view. Scan the barcode on the machine. **All** measurements saved with this barcode are shown.



Print file (Optional)

Part no. 03-1004

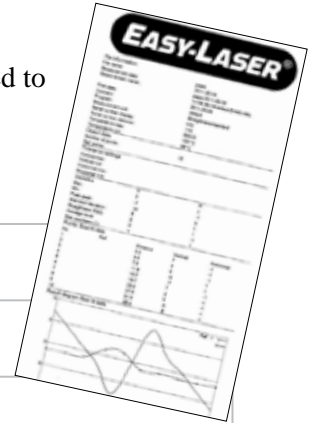

The thermal printer is optional equipment.

1. Save the measurement. To print from a Shaft program, you need to open a saved measurement before you can print a report.
2. Connect the thermal printer and select  and .
3. The progress is displayed on the status bar.



	Printing report on thermal printer.
	Printing performed OK.
	Printing problem.

Control panel

Select  and  to open the Control panel. Some of the settings are personal and will be default next time you start the system.



Note!

All settings are not available for all systems.

Filter

Select  to open the Filter view.

The filter you select on the Filter view will be saved as a personal setting.

If the laser beam passes through air with varying temperature, this may influence the direction of the laser beam. If measurement values fluctuate, this could mean unstable readings. Try to reduce air movements between laser and detector by, for instance, moving heat sources, closing doors. If the readings remain unstable, increase the filter value (more samples will become available to the statistical filter).

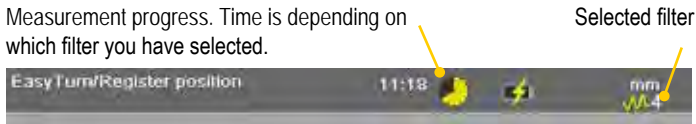

Select filter

Use as short a time as possible that still produces acceptable stability during the measurement. Default is set to 1. Normally you will use a filter value of 1-3. If you set the filter type to 0, no filter will be used. Use the numerical buttons 3, 6 and 9 to set the filter. In the Filter view but also when you are using a measuring program.



Use numerical buttons to select filter

Current noise level in the system before and after filtering

Press function button 6 to test how long the measurement progress is

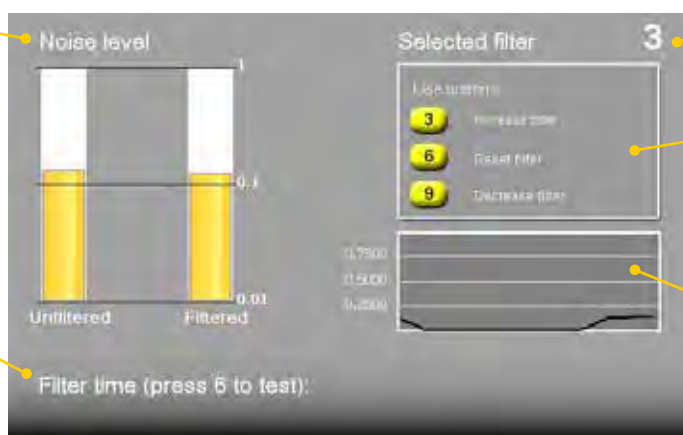

Currently selected filter

Use numerical buttons to set filter. Button 6 will restart the filter

Graph shows filtered noise level over time

Unit and resolution

Personal setting

Select  to open the Units and resolution view. Use the navigation buttons to move between the fields. Set Metric or Imperial and which resolution you want to use. Default is set to 0.01 mm (0.4 mil). The selected unit is shown on the Status bar.

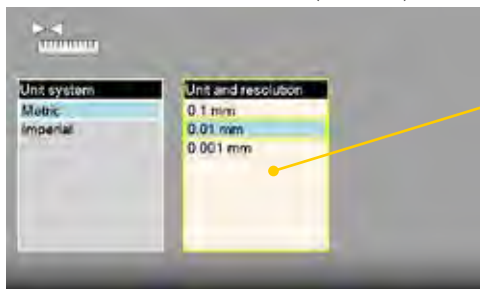



Note!

It is possible to select 0.0001mm only in the E940 system.

For E420, only 0.01mm is possible.

Language

Personal setting

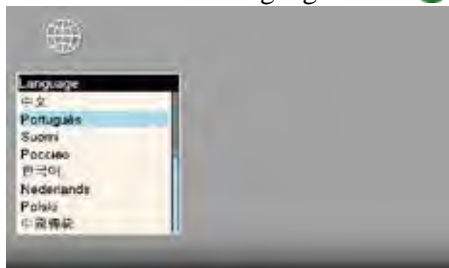

Select  to open the Language view. Default is set to English. Use the navigation buttons to select a language. Press  to save changes.



Language view

User

Select  to open the Users view. A user account is used for storing your personal settings.

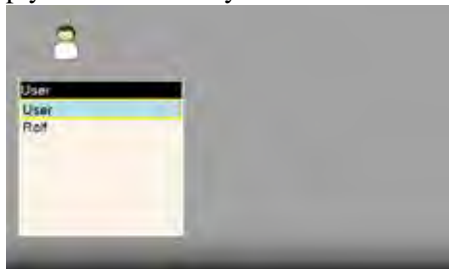

Use the function buttons   to add or remove users. To switch user, simply select the user you would like to switch to and press .



User view

Backlight

Personal setting

Select  to open the Backlight view. Use the navigation buttons to move between the fields. Press  to save changes. When backlight is off, the left LED signal will flash to indicate that the Display unit is still on.

Backlight level

Adjust the backlight to make it easier to read in bright sunlight. Remember however that a high contrast consume more battery power. Default is set to 50%.

Reduce after

Set time before backlight reduction as a way to save energy. The Display unit will be dimmed, but is still on. Default is set to Never.

Off after

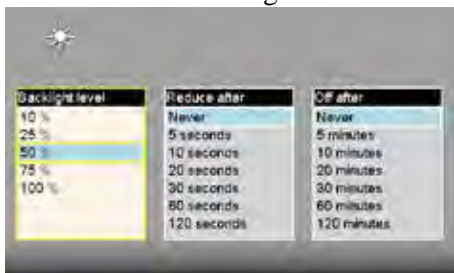

Set time before backlight off. Default is set to Never.



Backlight view

Automatic power off

Personal setting

Select  to open the Automatic off view. Select how much time before automatic power off. Use the navigation buttons to select. Press  to save changes.

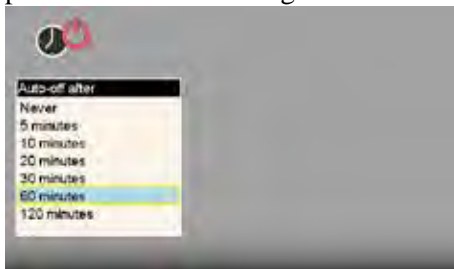

Automatic power off view

Note!

Measurements in progress will not be saved in the event of an Automatic power off.

Automatic sleep mode

Personal setting

Select  to open the Automatic sleep mode view. Select how much time before automatic sleep mode. Use the navigation buttons to select. Press **OK** to save changes.

See also “On/Off” on page 5.

Information

Select  to display the information regarding serial number and version of the equipment.

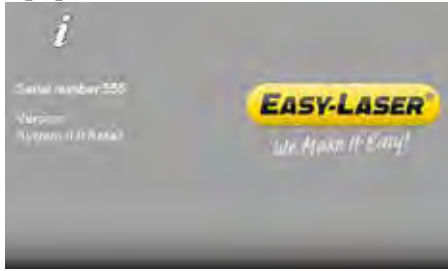

Information view

VGA

(Not available on all systems.)

Makes it possible to show display unit screen image with a projector, for example in a training context. Must be factory installed on order.

Select  to open the VGA view.

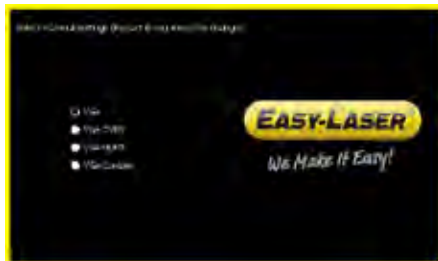

System update



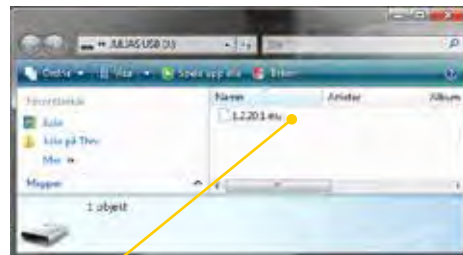

Download update file

1. Go to www.damalini.com > Download > Software > E series Display unit Firmware Update.
2. Download the update file to your PC.
3. Unzip the file.
4. Copy the .elu file to the root of a USB memory.



Save .elu file on a USB memory.

Install update file

1. Start the Display unit. Make sure that the internal battery of the Display unit is charged. The battery symbol should be at least yellow.
2. Insert the USB memory in the Display unit. Do not remove the USB memory until the update is finished.
3. Select  and  to display the System update view.
4. Select the update file and press .
5. Select . The installation starts.
6. The Display unit will automatically restart when the installation is finished and the Main menu is displayed.

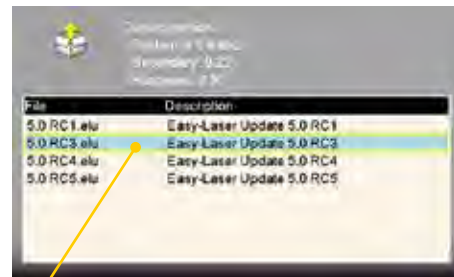

Select the .elu file.

Note!

During restart, the screen turns black for up to one minute. When the main menu is displayed, it can “freeze” (no response when you press buttons). If this happens, press the On/Off button for at least 15 seconds to restart the Display unit.



Main menu is automatically displayed after restart.

Font package

Some of the early E-series systems was not installed with Unicode fonts. To install the latest system updates, you need to install the font package with Unicode fonts.

Check if you need to install:

1. Select  and  to display the Language view.
2. Check if you have Chinese installed. **If Chinese is installed, you already have the correct Font package.** If not, please go to www.damalini.com > Download > Software > Eseries Display unit Font package update and follow the instructions above to install.

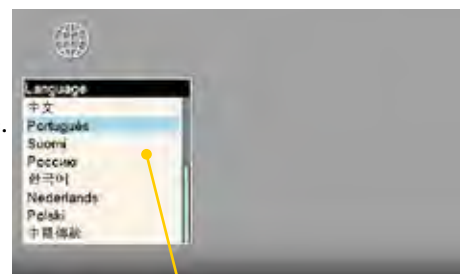



Chinese installed?
No need to update with Font package.

License

It is easy to upgrade your Display unit.



1. Contact your Easy-Laser® distributor if you wish to upgrade your Display unit.
2. An e-mail will be sent to you with information on how to download the update file.
3. Save the file to the root of the file system to a USB memory stick or directly to the Display unit.

Save file on USB

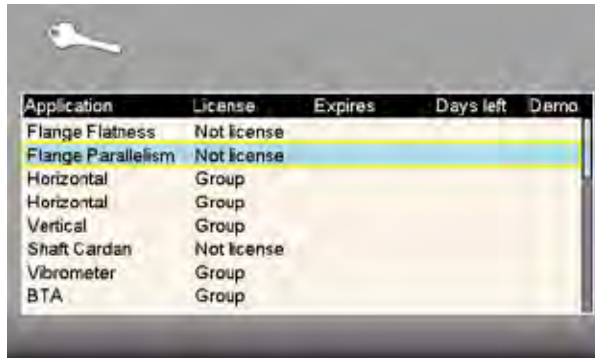
1. Save the downloaded license file to a USB memory stick.
2. Insert the USB memory stick in the Display unit.
3. Select  and  to display the License view.



Application	License	Expires	Days left	Demo
Flange Flatness	Not license			
Flange Parallelism	Not license			
Horizontal	Group			
Vertical	Group			
Shaft Cardan	Not license			
Vibrometer	Group			
BTA	Group			

4. Select  to search for licenses.
5. Press  to import license.

Bluetooth® set up

Bluetooth® wireless technology makes it possible for Display unit and Detector to exchange data without using cables.



Some detectors have built-in Bluetooth®, others have a separate Bluetooth unit that you attach to the detector. *Please see Technical data for more information.*

Set up

This is only necessary when adding new Bluetooth® units to the list.

1. Select to open the Bluetooth® view.
2. Select to search for Bluetooth® units.
3. The view is updated with the Easy-Laser® Bluetooth® units you can connect to.

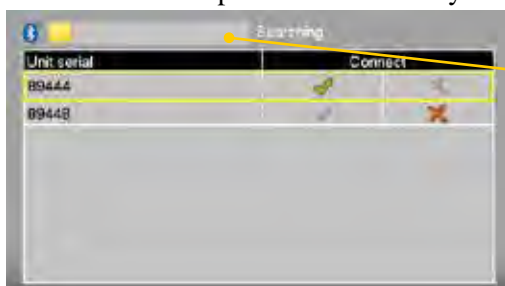

Searching for Bluetooth® units

4. Select the unit you want to connect to and select . The unit will automatically be connected when you start a measurement program.
5. Press to save changes and to leave the Bluetooth® view.
6. Enter a measurement program. The Display unit will connect to the selected units. While connecting, the left LED indicator is flashing with a blue light which will turn to a fixed blue light once connected.
7. An icon on the status bar will indicate how many Bluetooth® units are connected.



One Bluetooth® unit connected



Function buttons



	Back to Control panel. Changes made in the table are saved.
	Search for Bluetooth® units.
	Cancel search. Use if your Bluetooth® unit is already found.
	Remove a Bluetooth® unit from the list.
	Connect the unit. The unit will automatically connect when you start a measurement program.
	Disconnect the unit. The unit will remain in the list.

Obs!

Använd inte en Bluetooth®-enhet och en kabel samtidigt.

Use only one Bluetooth® unit

Many of our systems are delivered with two Measuring units. In some cases you might want to use only one unit together with a laser transmitter. By default both units are set to “Connect ”. If the unused unit is set to “Connect ”, the system will keep on trying to connect to it, even if it is not plugged in.

1. Attach the Bluetooth unit to the detector.
2. Select  to open the Bluetooth® view.
3. Set the Bluetooth® unit you want to use to .
4. Make sure that the other units are set to .
5. Enter a measuring program.

The Display unit will connect to the selected unit. This may take a couple of minutes.

Note!

Remove Bluetooth® unit from the Measuring unit before putting the equipment in the carrying case. If attached, it will discharge the Measuring unit.

Bluetooth® information

This device contains

FCC ID: PVH0925

IC: 5325A-0925

This device complies with Part 15 of the FCC Rules.

Operation is subject to the following two conditions;

- (1) this device may not cause harmful interference, and
- (2) this device must accept any interference received, including interference that may cause undesired operation.

CHOOSE PROGRAM

Preparations

Before starting a measurement, there are several things that are good to check to ensure a good and accurate measurement.

- Ensure a good measurement environment. Strong sunlight, warning lights, vibrations and temperature gradients can affect the readings.
- Make sure the surfaces are clean.
- Ensure that the foundation of the machine is stable.
- Check for play and clearance in the bearing.



Values

Shows live readings from S and M units.



Horizontal

For alignment of horizontal machines.



9-12-3. Measuring positions are registered at positions 9, 12, 3 o'clock.

EasyTurn™. Measuring positions are registered within 40°.



Vertical

For alignment of vertically mounted machines.



Softfoot

Check to ensure that the machine is resting evenly on all its feet.

PROGRAM VALUES



With the program Values, you can see live readings from the detectors. As default, a target and a table is displayed.

Press **OK** to register values.

Live vertical values

Detector value / Target

15:48 mm

Detector or Measuring unit V 3.81

Serial number 35455 (1/2)

Unit one (out of two connected)

Target

Tolerance area

Laser line

Current range

#	V	H
1	6.17	
2	5.41	
3	3.82	
4		



Registered values

Use the navigation buttons to scroll the list

Function buttons

	Back, leave program.
	<ul style="list-style-type: none"> See "Control panel" on page 15. See "Tolerance" on page 26. See "Zoom" on page 26. Save file. See "Measurement file handling" on page 11. See "Automatic recording" on page 28. Delete registered values. Print report on thermal printer (optional equipment).
	Set current value to zero.
	Halve displayed value.
	Return to absolute value. Only available after zeroing or halving.
	Choose how to display values. Use left and right navigation button to switch between two or more detectors when only one target is displayed.

Tolerance

1. Select  and  to set tolerance.
It is possible to set different tolerance in vertical and horizontal direction.
2. Use navigation buttons to move between the fields and to change the tolerance.
3. Press **OK**.

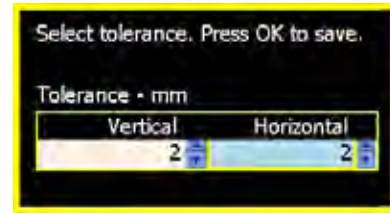



Live values and marking displayed in green when within tolerance.



Live values displayed in red when outside tolerance.



Zoom

1. Select  and  to zoom.
2. Select a zoom factor between 1–5. Use navigation buttons to increase or decrease zoom factor.
3. Press **OK**.

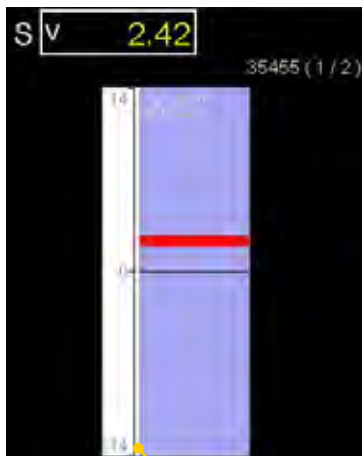

Default view

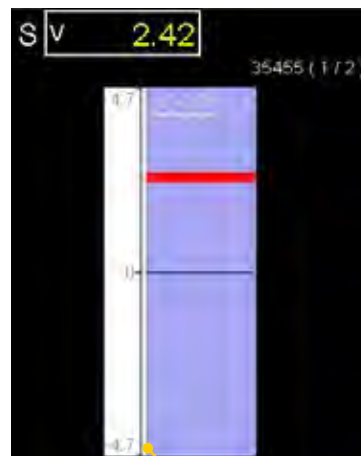

Zoom factor is set to 3

Edge warning

When the laser beam is close to the edge, the edge is “lit up” as a warning. It is not possible to register values when you see the edge warning.

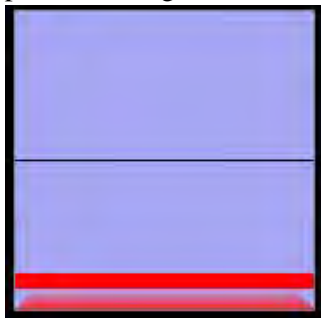

Halve or Zero set value

Half value

Select $\frac{1}{2}$ to half displayed value.

Zero line of the PSD moves halfway towards the laser line.

Zero set value

Select 0 to zero set displayed value.

Zero line of the PSD moves to the laser line.

Absolute value

Select $\frac{1}{4}$ to return to the absolute value.

Zero line of the PSD returns to the PSD centre.

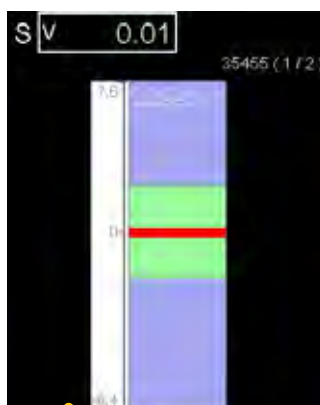
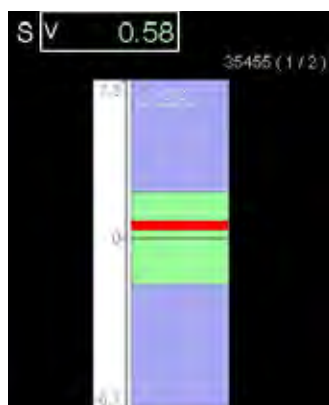

Note the change of the current range

Live values – colours

Live values are yellow

Green when within tolerance

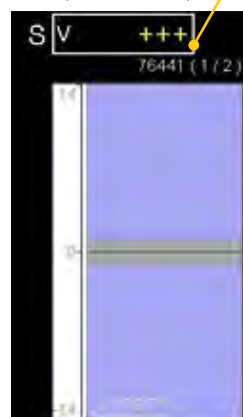
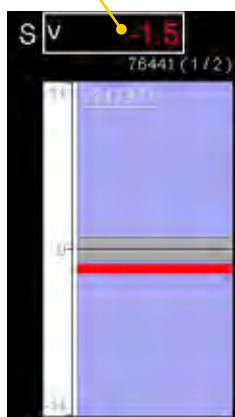

Red when outside tolerance

Loss of signal, laser beam interrupted for example



Automatic recording

In Values, it is possible to make automatic recording of values. This is very useful when you want to register values during a longer time period for example.

1. Select  and  to start automatic recording.
2. Set Interval.
3. Press navigation button “right”.
4. Set Duration.
5. Press **OK**. The recording will start and you can follow the progress on screen.



Icon indicates that values are being recorded



Views

You can decide how to display the current values. As default a target and a table is displayed, but you can choose to show only target for example.

Select  to display the different layout options, see image below.

Note!

Use left and right navigation button to switch between two or more detectors when only one target is displayed.

Precision level E290

Connect the Precision level via Bluetooth, see “Bluetooth® set up” on page 21.

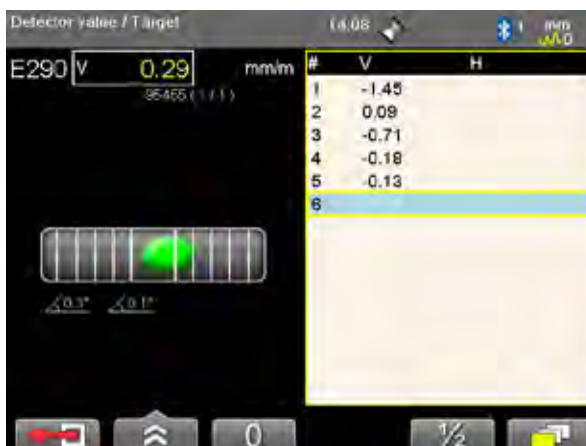

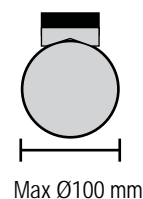

When measuring a shaft using the Precision level, we recommend that the shaft is no larger than 100 mm in diameter.



Calibration check

Use the program Values to check if the detector readings are within specified tolerances.

Quick check

1. Set the tolerance to 0.01 mm (0.5mil).
2. Select  and show targets for both M- and S-unit.
3. Select  to zero set value.
4. Place a shim under the magnet base to lift the M-unit 1mm (100mils). The M-unit's reading shall correspond to the movement within 1% (1mil \pm 1 digit) (0.01mm \pm 1 digit).
5. Remove the shim from the M-unit.
6. Select  to zero set value.
7. Make a mark to mark out the position of the detector.
8. Place the shim under the magnet base of the S-unit. The S-unit's reading shall correspond to the movement within 1% (1mil \pm 1 digit) (0.01mm \pm 1 digit).

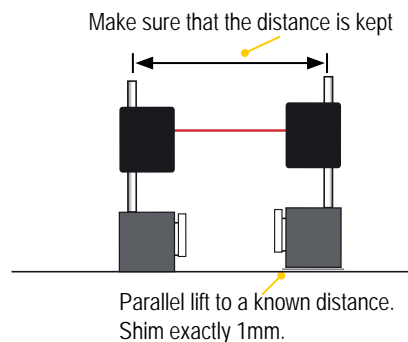

Note!

The shim must be exactly 1 mm. In this example it is only the M-unit that is checked.

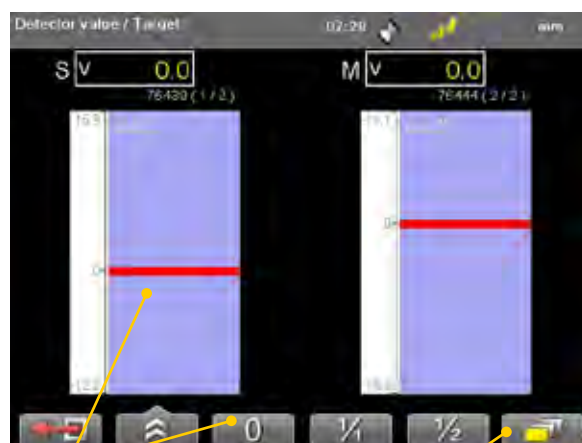

Zero set value

Select to show both targets.

Precision check

1. Fasten one unit in a machine tool.
2. Select  to zero set value.
3. Move the units a known distance is to use the movement of a machine tool spindle.
4. The fastened unit's reading shall correspond to the movement within 1% (1mil \pm 1 digit) (0.01mm \pm 1 digit).

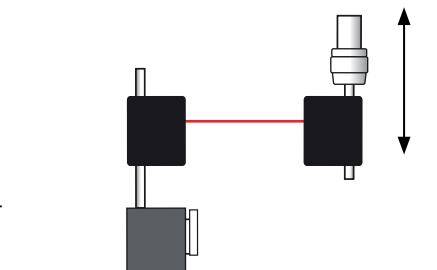

Note!

In this example it is only the unit fastened in the machine that is checked.

HORIZONTAL



For horizontally mounted machines.

Select between two different measuring methods:



EasyTurn™

Start anywhere on the turn. The three measuring positions can be registered with as little as 20° between positions. By default, the EasyTurn program is shown.

See “Measure using Easy Turn™” on page 35.



9-12-3

The measuring positions are registered at positions 9, 12, 3 o'clock. The inclinometers are not used.

“Measure using 9-12-3” on page 36.

Note!

Measurements made with older versions of the Horizontal program are opened with the older version of the program. For information regarding the previous program version, please see corresponding manual.

Work flow

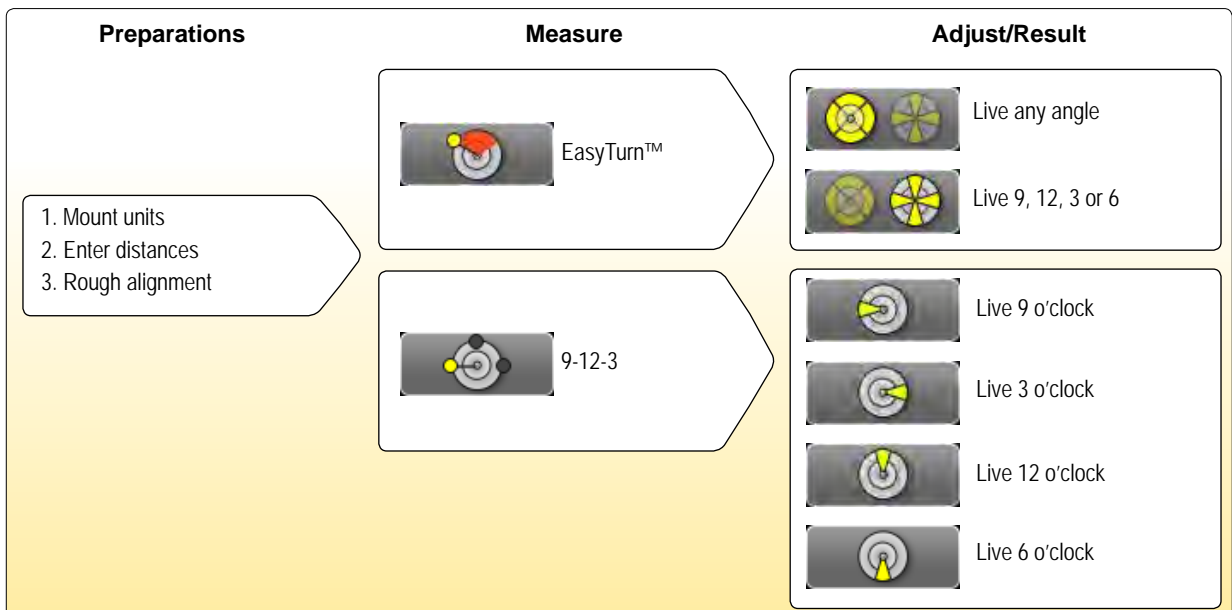

Mount the units

1. Mount the S-unit on the stationary machine and the M-unit on the movable machine.
2. Mount the units facing each other. Make sure they are at the approximately same rotational angle.

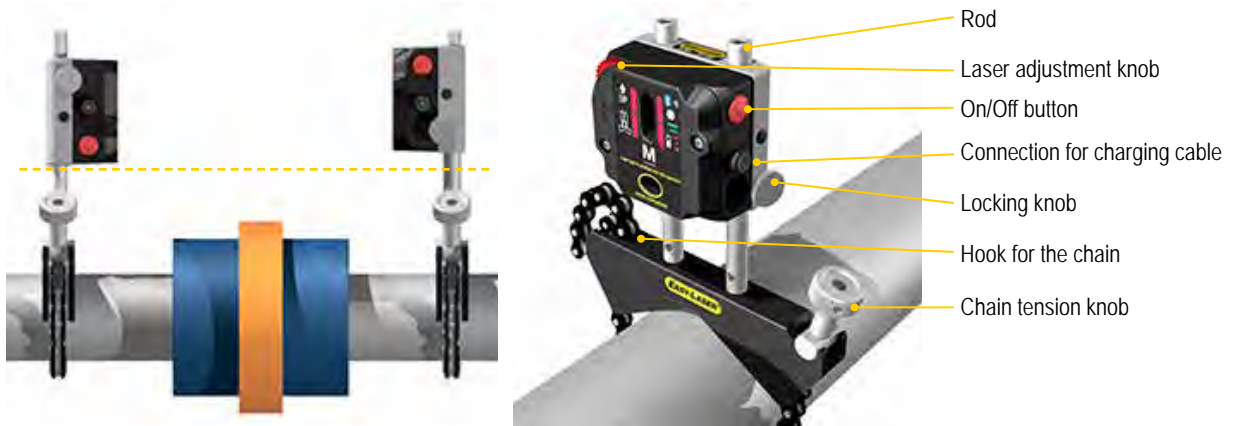

You need to place the measuring units with an offset, see image.

Bluetooth®

The Display unit and the measuring units are equipped with Bluetooth® wireless technology, which makes it possible for the Display unit to receive data without using cables. For more information, see “*Bluetooth® set up*” on page 21.

Adjust measuring units

Place the Measuring units on the rods, make sure they are at the approximately same rotational angle. You need to place the measuring units with an offset, see image. Also make sure that the adjustment knob is adjustable in both directions.

Image showing measuring units for E530 system.

1. Place the Measuring units at 9 o'clock. Adjust the laser line to the centre of both targets. Use the adjustment knob and/or move the detectors on the rods.

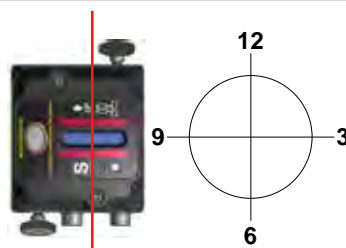

2. Turn the shafts 180°. Make a mark on the rods or machine halfway between the laser line and centre of both targets.

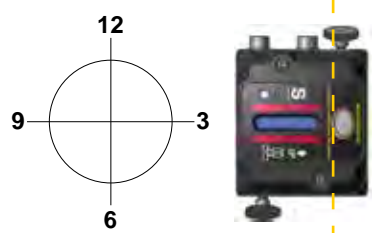

3. Adjust the laser beams half way to the centre of targets. Use the adjustment knobs and/or move the detectors on the rods.



4. Adjust the movable machine until the laser beam hits the centre of both targets.



5. Turn the shafts 180°. Check if both laser lines hit the targets. If not, repeat step 3–5.

Turn shafts to 12 o'clock. Repeat all steps for vertical adjustment.

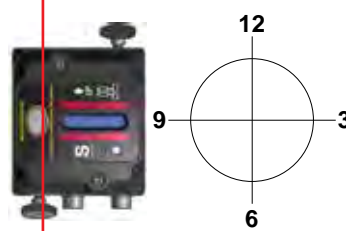





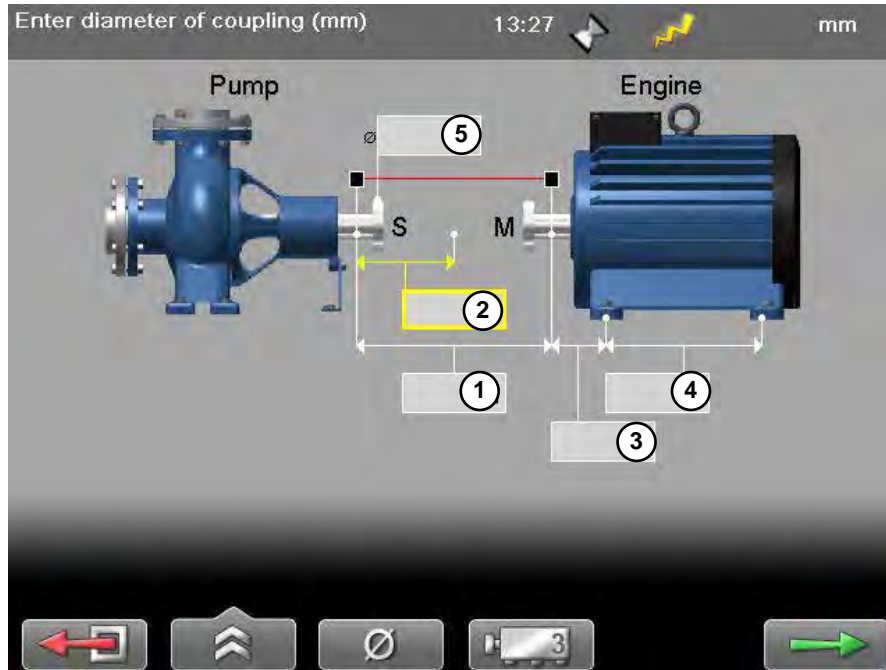



Enter distances

Confirm each distance with .



- ① Distance between S-unit and M-unit. Measure between the rods.
- ② Distance between S-unit and centre of coupling.
- ③ Distance between M-unit and feetpair one.
- ④ Distance between feetpair one and feetpair two.
- ⑤ Coupling diameter. Optional, select  to activate field.

Function buttons

	Leave program.
	 See "Control panel" on page 15.
	 See "Thermal compensation" on page 40.
	Diameter. Select to enter coupling diameter. This is necessary if you want the result based on the gap of the coupling instead of angle.
	Add a feet pair.
	Continue to Measure view.

Measure using Easy Turn™



Preparations

Follow the preparations as described in the previous pages.

1. Mount the measuring units.
2. Enter distances, confirm each distance with .
3. If needed, perform a rough alignment.
4. If needed, perform a Softfoot check.







Measure

It is possible to measure with as little as 40° spread between the measurement points. However, for an even more accurate result, try to spread the points as much as possible. The colours indicates where the optimum positions to measure are.

1. Adjust laser to the centre of the targets. If needed, adjust the units on the rods, then use laser adjustments knobs.
2. Press  to register first position. The first position is automatically set to zero. A red marking is displayed.
3. Turn shafts outside of the red 20° marking.
4. Press  to register second position.
5. Turn shafts outside of the red markings.
6. Press  to register third position. The Result and adjust view displayed.



Function buttons

	Back. Measure previous position or back to Distance view.
	See "Control panel" on page 15.
	 Switch to the EasyTurn™ method.
	 Switch to the 9-12-3 method.
	See "SOFTFOOT" on page 43.





Measure using 9-12-3

Preparations

Follow the preparations as described in the previous pages.

1. Mount the measuring units.
2. Enter distances, confirm each distance with .
3. If needed, perform a rough alignment.
4. If needed, perform a Softfoot check.

Measure



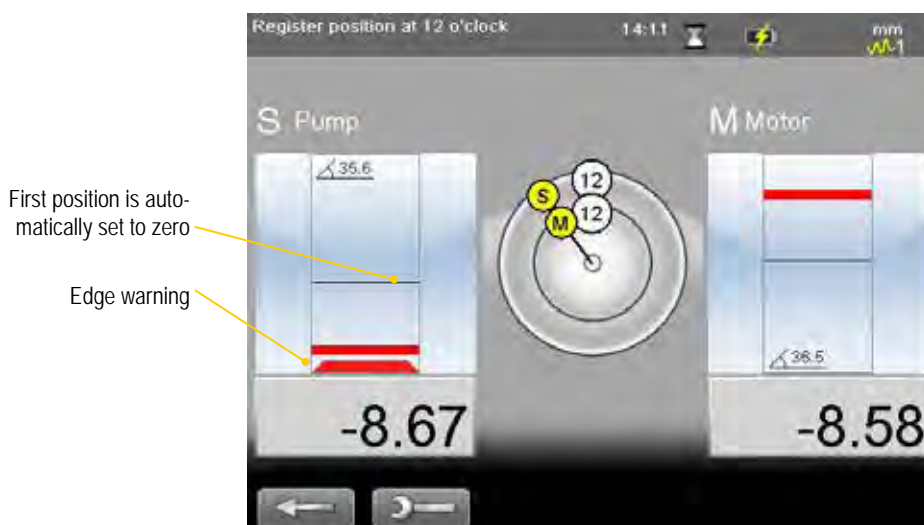



1. Select  and  to switch to 9-12-3.
2. Adjust laser to the centre of the targets. If needed, adjust the units on the rods, then use laser adjustments knobs.
3. Turn shafts to 9 o'clock.
4. Press  to register first position. The first position is automatically set to zero.
5. Turn shafts to 12 o'clock.
6. Press  to register second position.
7. Turn shafts to 3 o'clock.
8. Press  to register third position. The Result and adjust view is displayed. See “Result and adjust” on page 37.



Edge warning

When the laser beam is close to the edge, the edge is “lit up” as a warning. It is not possible to register values when you see the edge warning.

Function buttons

	Back. Measure previous position or back to Distance view.
	See “Control panel” on page 15.
	 Switch to the EasyTurn™ method.
	 Switch to the 9-12-3 method.
	 Switch to the Horizontal Multipoint method.
	See “SOFTFOOT” on page 43.

Result and adjust

Offset, angle and feet values are clearly displayed. Both horizontal and vertical direction are shown live, which makes it easy to adjust the machine. Values within tolerance are green.

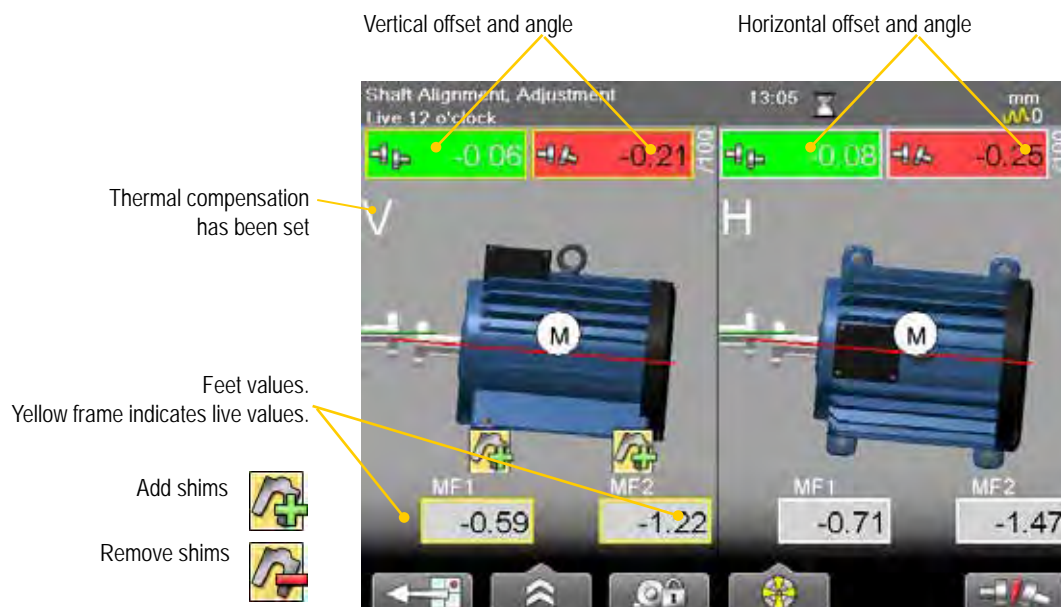

Function buttons

	Back to measure view.
	<ul style="list-style-type: none"> See "Control panel" on page 15. Save, see "Measurement file handling" on page 11. See "Tolerance" on page 41. See "Thermal compensation" on page 40. Show target. This is a quick way to see where the laser beam hits the target and how the measuring units are positioned. Print report on thermal printer (optional equipment). Available when you open a saved measurement. Edit distances. Press to confirm changes. The result is recalculated.
	RefLock, lock feet. <i>Note! Not available for E420.</i>
	<ul style="list-style-type: none"> See "Live values" on page 38. Toggle button. Show/hide Position indicator. See "Position indicator" on page 39.
	Toggle button. Switch between to show gap and show angular error per 100 mm. For this to work you need to set the coupling diameter.
	/100

Live values

When reading the values, face the stationary machine from the movable machine.
Positions for measuring units as seen from the movable machine.
Live values are marked with yellow frame.

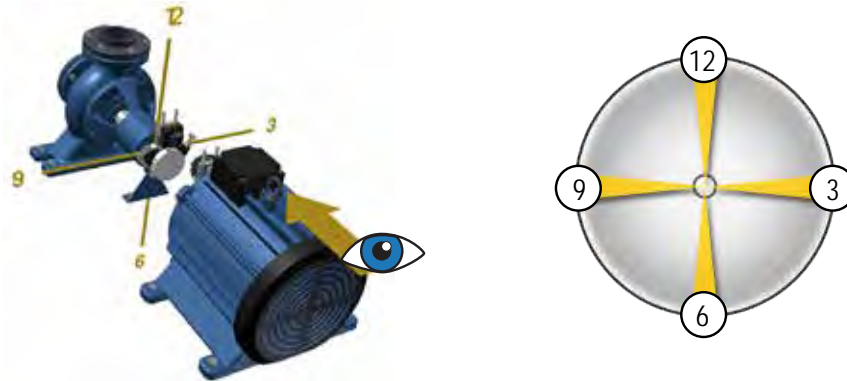

Face the stationary machine (S) from the movable machine (M). Then 9 o'clock is to the left, as in the measuring programs.

Offset and angle values

The offset and angle value indicate how well the machine is aligned at the coupling.
They appear in both horizontal and vertical direction.

These values are important to get within tolerance.

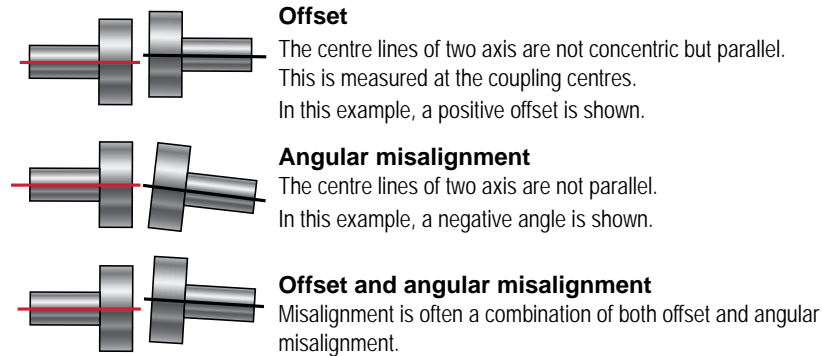

Show live values for EasyTurn™

The inclinometer can be used to show live values at all angles.

	Show live values at any angle.
	Inclinometer controls when to show live values.

Show live values for 9-12-3

The inclinometer is not used. You can manually show in which position your measurement units are.

Select to show the live options.

	Force live to 6 o'clock.
	Force live to 12 o'clock.
	Force live to 3 o'clock.
	Force live to 9 o'clock.

Adjust

Adjust the machine if needed.

1. Shim the machine according to the vertical feet values.
2. Adjust the machine sideways according to the live horizontal values.
3. Tighten the feet.
4. Select  to remeasure.



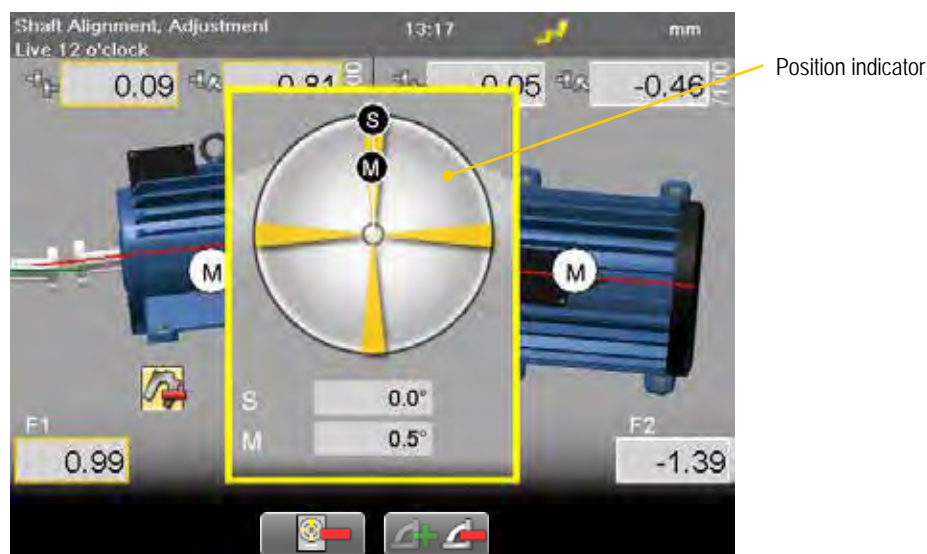

Position indicator

To adjust, you need to place the measuring units in live position (9, 12, 3 or 6 o'clock).

Select  to show the Position indicator.



Function buttons

 	Toggle button. Show/hide position indicator manually.
 	Toggle button. Select  to display the position indicator automatically when you move the measuring units.



Save

You can save a measurement and open it later to continue to measure. When you save the measurement again, it will **not** overwrite the earlier version.

See “Measurement file handling” on page 11.

Thermal compensation

During normal operation, machinery is influenced of different factors and forces. The most common of these changes is the change in the temperature of the machine. This will cause the height of the shaft to increase. This is called thermal growth. To compensate for thermal growth, you enter values for cold condition compensation.

Select  and  from the result and distance view. The Thermal compensation view is displayed.

Example

It can be necessary to place the cold machine a bit lower to allow thermal growth. In this example we assume a thermal growth of +5mm in **HOT** condition. Therefore we compensate with -5mm in **COLD** condition.

1 Before thermal compensation.

2 Set thermal compensation.

Indicates that the compensation values are set for cold (offline) condition.



Vertical offset and angle for movable machine.

3 Thermal compensation set. When you have set thermal compensation and return to the result view, the values have changed. When the machine becomes warm, the thermal growth will make it perfectly aligned.

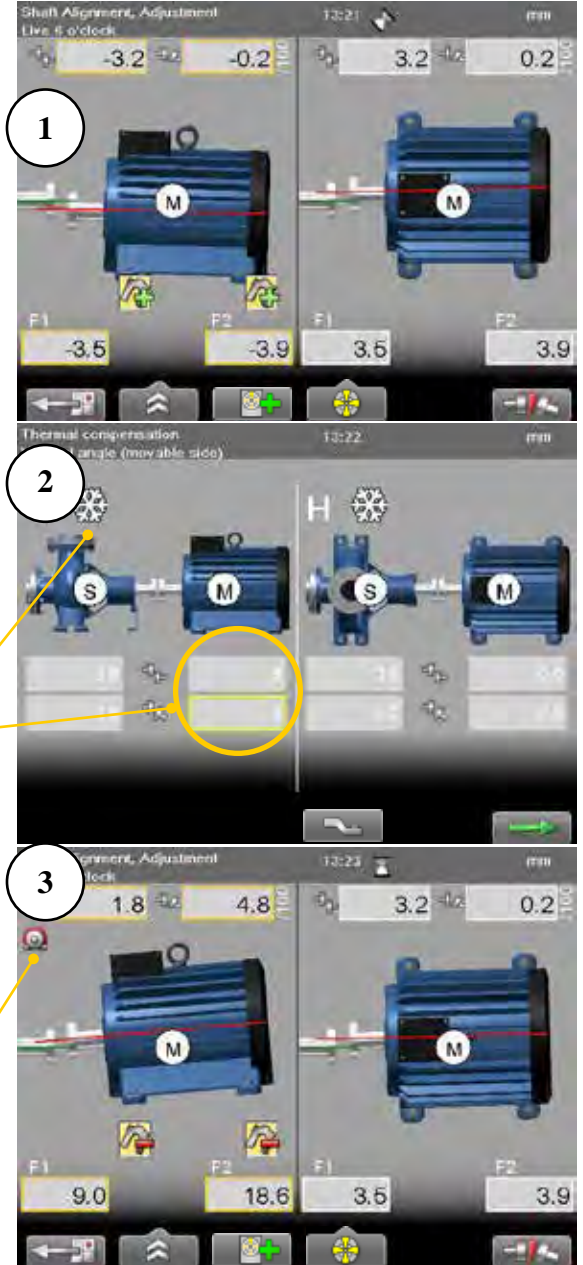
Indicates that thermal compensation has been set



Tolerance



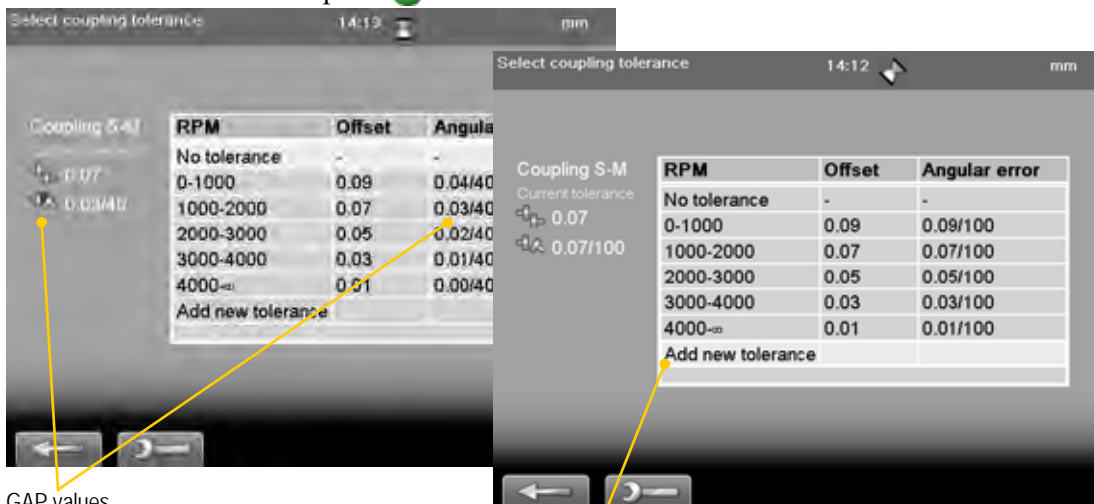

1. Select  and . The tolerance window is displayed.
2. Select a tolerance and press .



GAP values



Add user defined tolerance

Function buttons

	Close Tolerance view.
	See "Control panel" on page 15.
	Edit user defined tolerance.
	Delete user defined tolerance.

Add new tolerance

You can add your own user defined tolerance.

1. Select the row "Add new tolerance". Press .
2. Enter name and tolerance.
3. Press . The new tolerance is added to the list.



Tolerance in result views

The tolerances are clearly displayed in the result views.

Green = within tolerance

Red = not within tolerance

Tolerance table

The rotation speed of the shafts will decide the demands on the alignment. The table on this side can be used as a guidance if no other tolerances is recommended by the manufacturer of the machines.

The tolerances is set to the maximum allowed deviation from accurate values, with no consideration to if that value should be zero or compensated for thermal growth.

Offset misalignment

rpm	Excellent		Acceptable	
	mils	mm	mils	mm
0000-1000	3.0	0.07	5.0	0.13
1000-2000	2.0	0.05	4.0	0.10
2000-3000	1.5	0.03	3.0	0.07
3000-4000	1.0	0.02	2.0	0.04
4000-5000	0.5	0.01	1.5	0.03
5000-6000	<0.5	<0.01	<1.5	<0.03

Angular misalignment

rpm	Excellent		Acceptable	
	mils/''	mm/100mm	mils/''	mm/100mm
0000-1000	0.6	0.06	1.0	0.10
1000-2000	0.5	0.05	0.8	0.08
2000-3000	0.4	0.04	0.7	0.07
3000-4000	0.3	0.03	0.6	0.06
4000-5000	0.2	0.02	0.5	0.05
5000-6000	0.1	0.01	0.4	0.04

The higher the rpm of a machinery is, the tighter the tolerance must be. The acceptable tolerance is used for re-alignments on non-critical machinery. New installations and critical machines should always be aligned within the excellent tolerance.

Note!

Consider these tables as guidelines. Many machines must be aligned very accurately even if they have a lower rpm. For example gearboxes.

SOFTFOOT



Perform a softfoot check to ensure that the machine is resting evenly on all its feet. A softfoot can be angular and/or parallel, see image.

Softfoot can be caused by:

- Twisted machinery foundations.
- Twisted or damaged machinery feet.
- Improper amount of shims under machine feet.
- Dirt or other unwanted materials under machine feet.

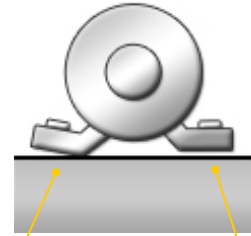

Angular softfoot

Parallel softfoot

Start Softfoot from main shaft menu

1. Select and .
2. Enter distances.
3. Select to continue.

Start Softfoot from Horizontal program

1. Select and to open Horizontal program.
2. Enter distances. Confirm each distance with **OK**. To perform a Softfoot check, you need to enter distances between the feet pairs. The measure view is displayed.
3. Select . Softfoot is only available before you have registered any measurement points.

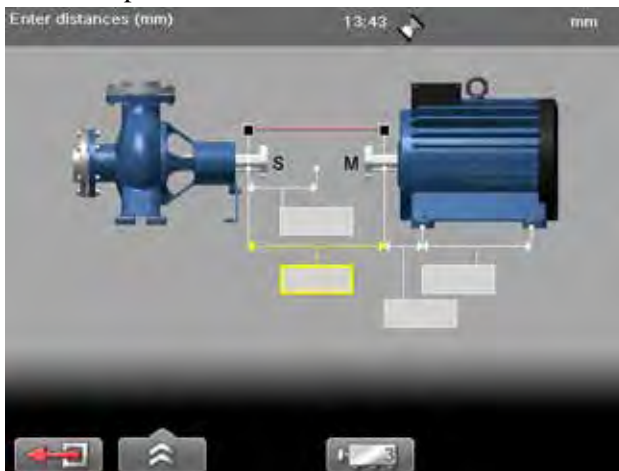

Function buttons

	Leave program.
	See "Control panel" on page 15.
	Add a feet pair.
	Continue to Measure view. Available when you have entered the distances.

Measure softfoot

1. Tighten all feet bolts.
2. Turn the measuring units to 12 o'clock.
3. Adjust laser to the centre of targets. If needed, adjust the units on the rods, then use laser adjustments knobs.



Turn the measuring units to 12 o'clock.

Adjust laser line to centre of target.

4. Press **OK**. The Softfoot measure view is displayed. The first bolt is marked with yellow.
5. Loosen and then retighten the first bolt.
6. Press **OK** to register value.
7. Register values on all four feet. The result is displayed.
8. Shim the foot with the largest movement.
9. Do a Softfoot check again.

Measure:

Loosen and retighten bolt before register value.



Result:









Arrow indicating that the machine is tilting in this direction.



Note!

If the largest movement is opposite from the smallest it is not a conventional softfoot and you will be asked to check the foundation.

Function buttons



	Leave Softfoot.
	 See "Control panel" on page 15.
	 Save. Only available when you have started Softfoot from the main menu.
	Zero value of selected foot.
	Toggle button to switch machine. To check Softfoot, distances between feet pairs are necessary. If needed, the Enter distance view is displayed. <i>Not available for E420.</i>
	Remeasure Softfoot.
	Continue to Measure view, only available when you have started Softfoot from the program Horizontal.

VERTICAL





The program Vertical is used for vertical and/or flange mounted machines.

Preparations



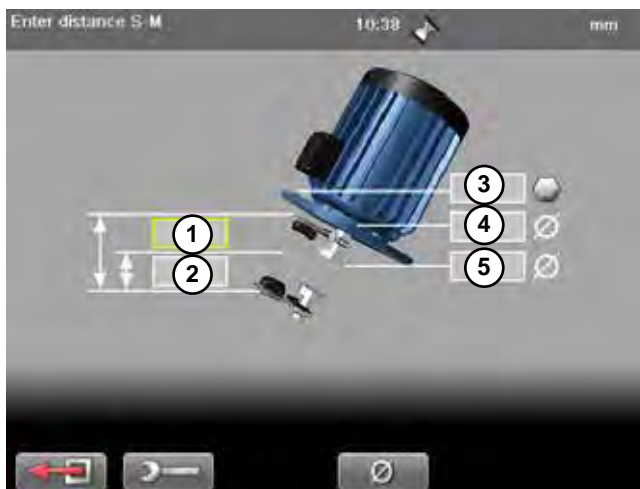

1. Mount the M-unit on the movable machine and the S-unit on the stationary machine.
2. Select  and  to open Vertical program.
3. Enter distances. Confirm each distance with .

If you have a barcode reader, simply scan the barcode and all machine data is read.
See “Measurement file handling” on page 11.





- 1 Distance between S-unit and M-unit.
Measure between the rods. **Mandatory.**
- 2 Distance between S-unit and centre of coupling. **Mandatory.**
- 3 Number of bolts (4, 6 or 8 bolts).
- 4 Bolt circle diameter (centre of the bolts).
- 5 Coupling diameter. Select  to activate field.

Function buttons

	Leave program.
	See “Control panel” on page 15.
	Select to enter diameter of coupling.
	Forward to measure view.

Measure

The program Vertical uses the 9-12-3 method.

1. Position the units at 9 o'clock, at bolt number one. Make sure that it is possible to also position the units at 12 and 3 o'clock.
2. Press  to register first position. The first position is automatically set to zero.
3. Turn units to position 12 o'clock.
4. Press  to register position.
5. Turn units to position 3 o'clock.
6. Press  to register position. Measurement result is displayed.

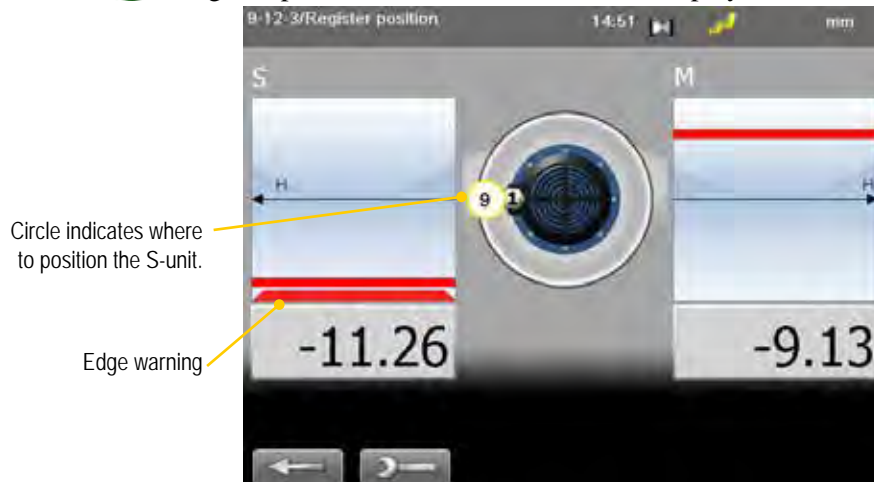

Edge warning

When the laser beam is close to the edge, the edge is “lit up” as a warning. It is not possible to register values when you see the edge warning.

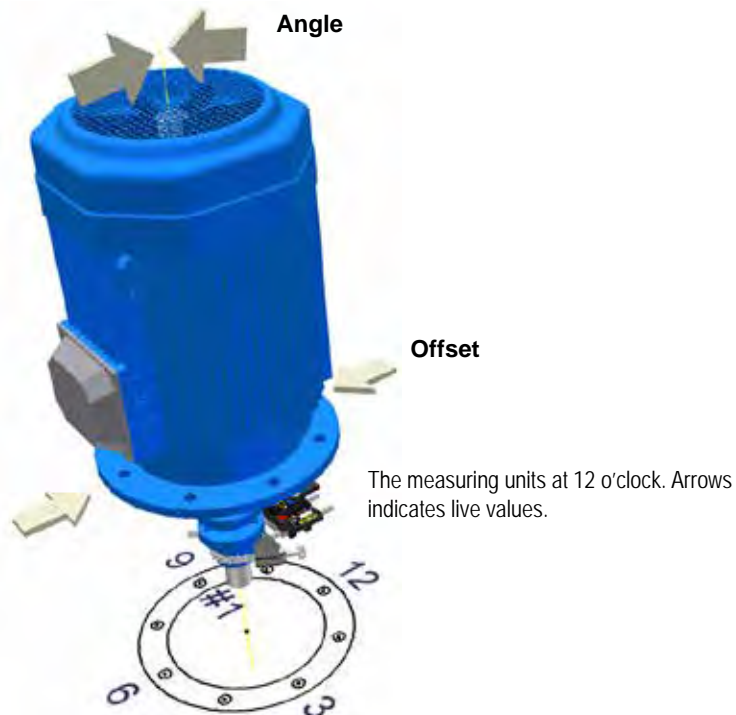

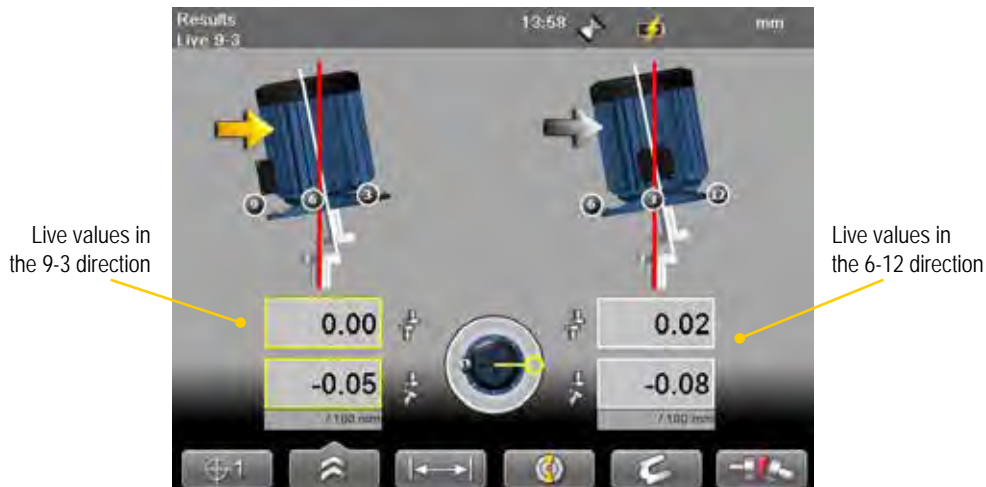

Result

The result is displayed as sideways offset in the coupling and angular error between shafts.





















Live values

The values can be displayed live in two directions:

- Live in the 9-3 direction.
Select  and position the measuring units at 3 o'clock.
- Live in the 6-12 direction.
Select  and position the measuring units at 12 o'clock.



Function buttons

	Back, remeasure from first position.
	 See "Control panel" on page 15.
	 Save, see "Measurement file handling" on page 11.
	 Set tolerance.
	 Show target. This is a quick way to see where the laser beam hits the target and how the measuring units are positioned.
	 Print report on thermal printer (optional equipment). Only available when you open a saved measurement.
	Adjust distances. Press  to confirm changes. The result is recalculated.
 	Toggle button. Switch between showing live values in the direction 9-3 or 6-12.
	See "Shim result view" on page 48.
 	Toggle button. Switch between to show gap and show angular error per 100 mm. For this to work you need to set the coupling diameter.

Shim result view

To view this, you need to enter number of bolts and diameter of bolt circle.



1. Select  to open Shim value view. The values are not live.
2. Read values. The highest bolt is calculated as 0.00. Values below zero indicates that the bolt is low and need shimming.
3. Select  to return to Result view.

Note!

If you shim the machine, remeasure from position 9 o'clock to update all measurement values.

Adjust machine

1. Compare the offset and angular error to the tolerance demands.
2. If the angular error need to be adjusted, please shim the machine first, then adjust the offset.
3. Tighten the bolts and remeasure.

TECHNICAL DATA

System Easy-Laser® E420 Shaft, Part No. 12-0745



A complete system contains

1	Measuring unit M
1	Measuring unit S
1	Display unit
2	Shaft brackets with chains
1	Set of rods 4x60 mm, 4x120 mm [4.72", 2.36"]
1	Measuring tape 3 m
1	Power adapter (100–240 V AC)
1	DC split cable for charging
1	DC to USB adapter, for charging
1	Quick reference manual
1	USB memory with manuals and EasyLink™ PC software
1	CD with documentation
1	Carrying case

System

Relative humidity	10–95%
Weight (complete system)	6.3 kg [13.9 lbs]
Carrying case	WxHxD: 500x415x170 mm [19.7"x16.3"x6.7"]

Display unit E53

Part no. 12-0748

In the Display unit you are guided through the measurement procedure and can save and analyze the results.



Display unit	
Type of display/size	VGA 5.7" colour, backlit LED
Displayed resolution	0.001 mm / 0.05 thou
Internal battery (stationary)	Heavy duty Li Ion chargeable
Operating time	Approx. 30 hours (Normal operating cycle)
Temperature range	-10–50 °C
Connections	USB A, Charger
Wireless communication	Class I Bluetooth® wireless technology
Internal memory	>2000 measurements can be saved
Help functions	Calculator, Converter
Environmental protection	IP Class 65
Housing material	PC/ABS + TPE
Dimensions	WxHxD: 250x175x63 mm [9.8x6.9x2.5"]
Weight (without batteries)	910 g [2.0 lbs]
Cables	
Charging cable (splitter)	Length 1 m [39.4"]
Brackets etc	
Shaft brackets	Type: V-fixture for chain, width 18 mm [0.7"]. Shaft diameters: 20–450 mm [0.8"–17.7"] Material: anodised aluminium
Rods	Length: 120 mm, 60 mm [4.72", 2.36"] (extendable) Material: Stainless steel
EasyLink™ data base software for PC	
Minimum requirements	Windows® XP, Vista, 7. For the export functions, Excel 2003 or newer must be installed on the PC.

Note!

See also "Power adaptor" on page 9.

Measuring units

Part no. 12-0746

Part no. 12-0747



1. Press On.
2. Establish a Bluetooth® connection, see "Bluetooth® set up" on page 21. The unit will search for a Bluetooth® connection for 5 minutes before it will turn off.

If the connection is lost, the units will keep searching for a connection during ten minutes before being switched off automatically.

Measuring units	
Type of detector	True PSD 20 mm [0.78"]
Wireless communication	Class I Bluetooth® wireless technology
Operating time	>4 h
Resolution	0.001 mm [0.05 mils]
Measuring errors	±1% +1 digit
Measurement range	Up to 3 m [10 feet]
Type of laser	Diode laser
Laser wavelength	635–670 nm
Laser safety class	Class 2
Laser output power	<1 mW
Electronic Inclinometers	0.1° resolution
Thermal sensors	-20–60 °C
Environmental protection	IP Class 65
Temperature range	-10–50 °C
Housing material	Anodized aluminium / ABS plastics
Dimensions	WxHxD: 69.0x61.5x41.5 mm [2.72"x2.42"x1.63"]
Weight	176 g [6.2 oz]

Note!

See also "Charge measuring units" on page 9.

INDEX

A

Angular misalignment 38

B

Barcode 8
Battery view 9
Bluetooth® 7
Buttons 5, 48

C

Calibration 3
Calibration check 29
Convert units 10

D

Display unit 48

E

EasyLink 3
elu file 19
Escape 5

F

File handling 11
Filter 15
Font package 19

G

Gap 32, 37

I

Icons 6
Imperial unit 16
Inclinometer 49

L

LED signal 5, 5, 49
License 20

M

Manuals as PDF 3
Measuring unit 49
Metric unit 16
M-unit 30

O

On/Off 5

P

PDF 16
Personal settings 15
Position indicator 37, 39
Precision level 26
Print 14
Projector 7

R

Resolution 16
Rotate coordinates 7
Rough alignment 31

S

Screen dump 8
Service centre 3
Settings 15
Sleep mode 5
Softfoot 41
Status bar 7
Submenu 6
S-unit 30

T

Template 13
Tolerance 41, 25

U

Unicode 19
Unit 16
Update system 19
Upgrade system 20
USB 13
User 16

V

Values 23, 26

W

Warning icon 7
Warranty 2

